

SPHV-C Series

200W Discrete Bidirectional TVS Diode

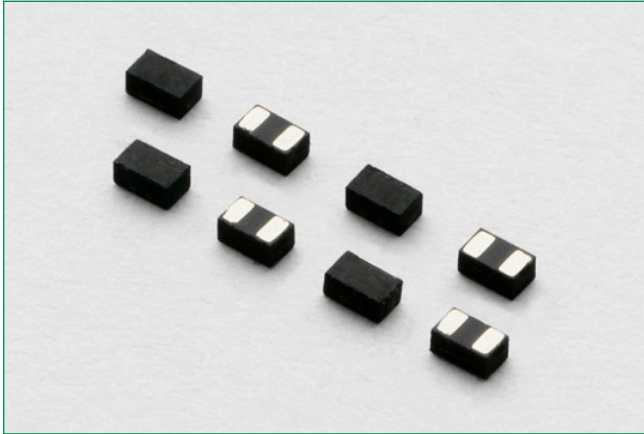

Description

The Bidirectional SPHV-C series is designed for use in portable applications, LED lighting modules, automotive applications, and low speed I/Os. It will protect sensitive equipment from damage due to electrostatic discharge (ESD) and other overvoltage transients.

The SPHV-C series can safely absorb repetitive ESD strikes above the maximum level of the IEC 61000-4-2 international standard (Level 4, $\pm 8\text{kV}$ contact discharge) without performance degradation and safely dissipate up to 8A (SPHV12-C) of induced surge current (IEC 61000-4-5, 2nd Edition $t_P=8/20\mu\text{s}$) with very low clamping voltages.

Features & Benefits

- ESD, IEC 61000-4-2, $\pm 30\text{kV}$ contact, $\pm 30\text{kV}$ air
- EFT, IEC 61000-4-4, 40A (5/50ns)
- Lightning, IEC 61000-4-5 2nd Edition, 8A ($t_P=8/20\mu\text{s}$, SPHV12-C)
- Low clamping voltage
- Low leakage current
- Small SOD882 packaging helps save board space
- Lead-free and RoHS compliant
- AEC-Q101 Qualified
- Side exposed leadframe helps to verify solderability (SPHV24-KTG-C)

Additional Information



Resources



Accessories



Samples

Pinout

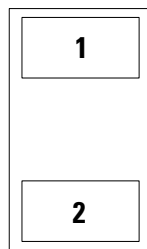

Applications

- LED Lighting Modules
- Portable Instrumentation
- General Purpose I/O
- Mobile & Handhelds
- RS232 / RS485
- CAN and LIN Bus

Functional Block Diagram

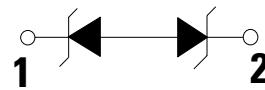

Life Support Note:

Not Intended for Use in Life Support or Life Saving Applications

The products shown herein are not designed for use in life sustaining or life saving applications unless otherwise expressly indicated.

SPHV-C Series

200W Discrete Bidirectional TVS Diode

Absolute Maximum Ratings

Symbol	Parameter	Value	Units
P_{pk}	Peak Pulse Power ($t_p=8/20\mu s$)	200	W
T_{OP}	Operating Temperature	-40 to 125	°C
T_{STOR}	Storage Temperature	-55 to 150	°C

CAUTION: Stresses above those listed in "Absolute Maximum Ratings" may cause permanent damage to the device. This is a stress only rating and operation of the device at these or any other conditions above those indicated in the operational sections of this specification is not implied.

SPHV12-C Electrical Characteristics (TOP=25°C)

Parameter	Symbol	Test Conditions	Min	Typ	Max	Units
Reverse Standoff Voltage	V_{RWM}	$I_R \leq 1\mu A$			12.0	V
Breakdown Voltage	V_{BR}	$I_R = 1mA$	13.3			V
Reverse Leakage Current	I_{LEAK}	$V_R = 12V$			1.0	μA
Clamp Voltage ¹	V_C	$I_{PP} = 1A, t_p = 8/20\mu s, Fwd$			19.0	V
		$I_{PP} = 8A, t_p = 8/20\mu s, Fwd$			25.0	V
Dynamic Resistance ²	R_{DYN}	TLP, $t_p = 100ns, I/O$ to GND		0.48		Ω
Peak Pulse Current	I_{PP}	$t_p = 8/20\mu s$			8.0	A
ESD Withstand Voltage ¹	V_{ESD}	IEC61000-4-2 (Contact Discharge)	± 30			kV
		IEC61000-4-2 (Air Discharge)	± 30			kV
Diode Capacitance ¹	$C_{I/O-I/O}$	Reverse Bias=0V, $f=1MHz$			30	pF

Note:

- Parameter is guaranteed by design and/or device characterization.
- Transmission Line Pulse (TLP) with 100ns width and 200ps rise time.

SPHV15-C Electrical Characteristics (TOP=25°C)

Parameter	Symbol	Test Conditions	Min	Typ	Max	Units
Reverse Standoff Voltage	V_{RWM}	$I_R \leq 1\mu A$			15.0	V
Breakdown Voltage	V_{BR}	$I_R = 1mA$	16.7			V
Reverse Leakage Current	I_{LEAK}	$V_R = 15V$			1.0	μA
Clamp Voltage ¹	V_C	$I_{PP} = 1A, t_p = 8/20\mu s, Fwd$			22.0	V
		$I_{PP} = 5A, t_p = 8/20\mu s, Fwd$			30.0	V
Dynamic Resistance ²	R_{DYN}	TLP, $t_p = 100ns, I/O$ to GND		0.43		Ω
Peak Pulse Current	I_{PP}	$t_p = 8/20\mu s$			5.0	A
ESD Withstand Voltage ¹	V_{ESD}	IEC61000-4-2 (Contact Discharge)	± 30			kV
		IEC61000-4-2 (Air Discharge)	± 30			kV
Diode Capacitance ¹	$C_{I/O-I/O}$	Reverse Bias=0V, $f=1MHz$			24	pF

Note:

- Parameter is guaranteed by design and/or device characterization.
- Transmission Line Pulse (TLP) with 100ns width and 200ps rise time.

SPHV-C Series

200W Discrete Bidirectional TVS Diode

SPHV24-C Electrical Characteristics (TOP=25°C)

Parameter	Symbol	Test Conditions	Min	Typ	Max	Units
Reverse Standoff Voltage	V_{RWM}	$I_R \leq 1 \mu A$			24.0	V
Breakdown Voltage	V_{BR}	$I_R = 1 mA$	26.7			V
Reverse Leakage Current	I_{LEAK}	$V_R = 24V$			1.0	μA
Clamp Voltage ¹	V_C	$I_{PP} = 1A, t_p = 8/20\mu s, Fwd$			36.0	V
		$I_{PP} = 3A, t_p = 8/20\mu s, Fwd$			50.0	V
Dynamic Resistance ²	R_{DYN}	TLP, $t_p = 100ns, I/O$ to GND		0.65		Ω
Peak Pulse Current	I_{PP}	$t_p = 8/20\mu s$			3.0	A
ESD Withstand Voltage ¹	V_{ESD}	IEC61000-4-2 (Contact Discharge)	± 24			kV
		IEC61000-4-2 (Air Discharge)	± 30			kV
Diode Capacitance ¹	$C_{I/O-I/O}$	Reverse Bias=0V, f=1MHz			17	pF

Note:

- Parameter is guaranteed by design and/or device characterization.
- Transmission Line Pulse (TLP) with 100ns width and 200ps rise time.

SPHV36-C Electrical Characteristics (TOP=25°C)

Parameter	Symbol	Test Conditions	Min	Typ	Max	Units
Reverse Standoff Voltage	V_{RWM}	$I_R \leq 1 \mu A$			36.0	V
Breakdown Voltage	V_{BR}	$I_R = 1 mA$	40.0			V
Reverse Leakage Current	I_{LEAK}	$V_R = 36V$			1.0	μA
Clamp Voltage ¹	V_C	$I_{PP} = 1A, t_p = 8/20\mu s, Fwd$			52.0	V
		$I_{PP} = 2A, t_p = 8/20\mu s, Fwd$			65.0	V
Dynamic Resistance ²	R_{DYN}	TLP, $t_p = 100ns, I/O$ to GND		1.33		Ω
Peak Pulse Current	I_{PP}	$t_p = 8/20\mu s$			2.0	A
ESD Withstand Voltage ¹	V_{ESD}	IEC61000-4-2 (Contact Discharge)	± 15			kV
		IEC61000-4-2 (Air Discharge)	± 20			kV
Diode Capacitance ¹	$C_{I/O-I/O}$	Reverse Bias=0V, f=1MHz			13	pF

Note:

- Parameter is guaranteed by design and/or device characterization.
- Transmission Line Pulse (TLP) with 100ns width and 200ps rise time.

Non-Repetitive Peak Pulse Power vs. Pulse Time

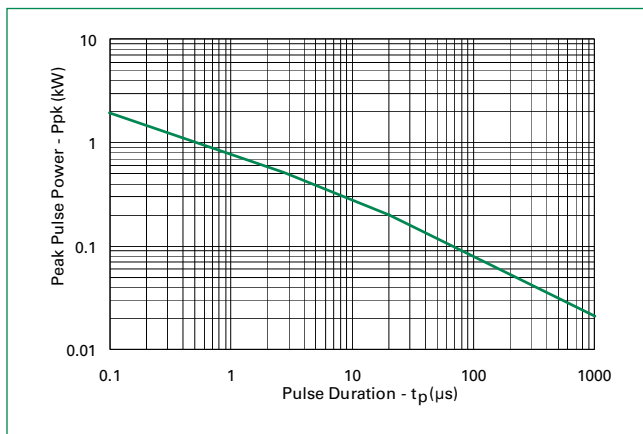

Power Derating Curve

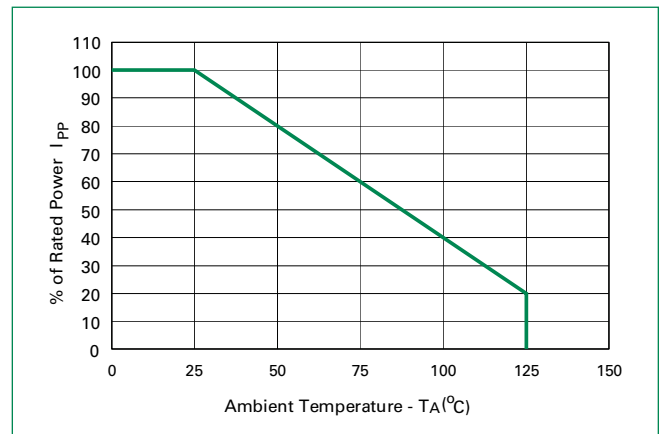

SPHV-C Series

200W Discrete Bidirectional TVS Diode

8/20μs Pulse Waveform

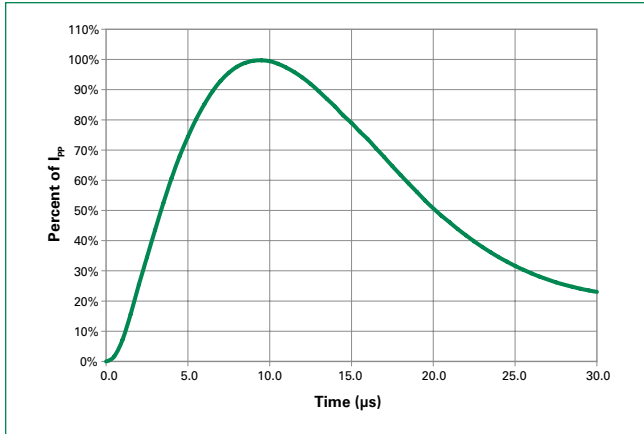

SPHV12-C Transmission Line Pulsing (TLP) Plot

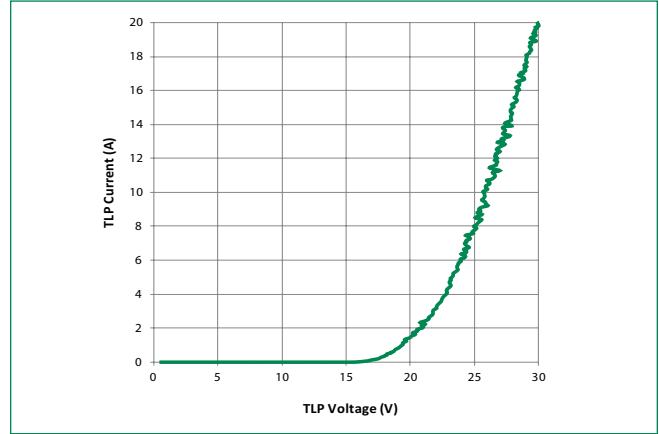

SPHV15-C Transmission Line Pulsing (TLP) Plot

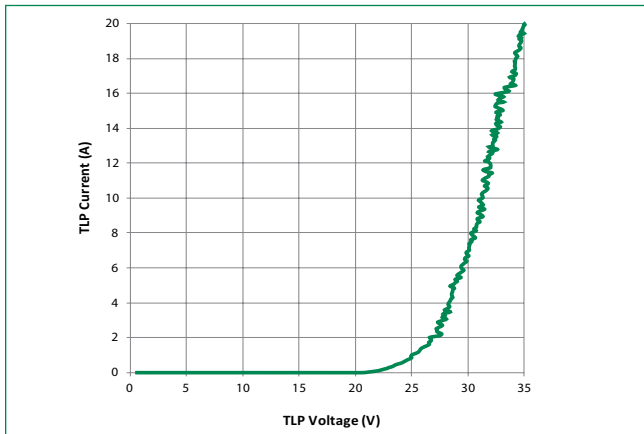

SPHV24-C Transmission Line Pulsing (TLP) Plot

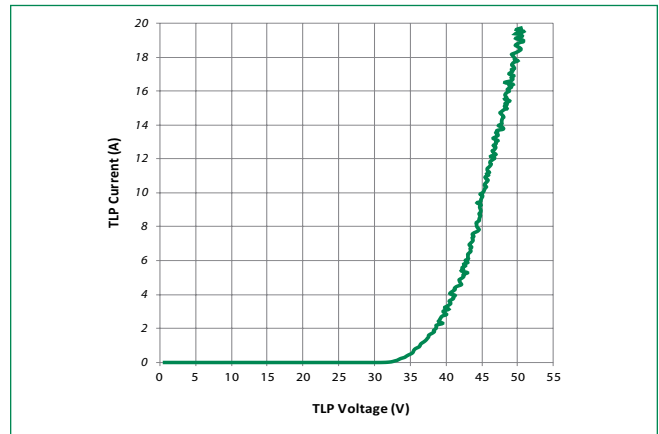

SPHV36-C Transmission Line Pulsing (TLP) Plot

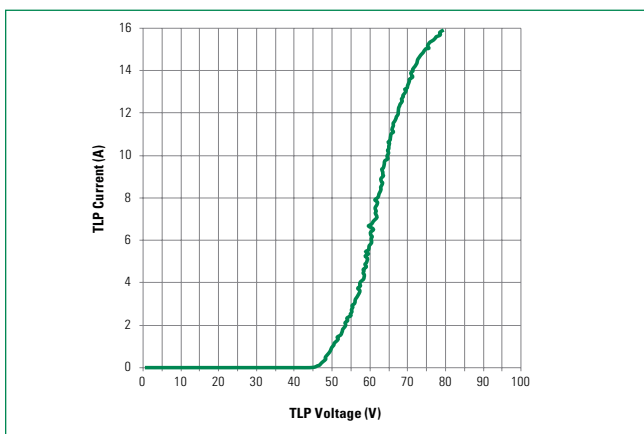

SPHV-C Series

200W Discrete Bidirectional TVS Diode

Soldering Parameters

Reflow Condition		Pb – Free assembly
Pre Heat	- Temperature Min ($T_{s(min)}$)	150°C
	- Temperature Max ($T_{s(max)}$)	200°C
	- Time (min to max) (t_s)	60 – 180 secs
Average ramp up rate (Liquidus) Temp (T_L) to peak		3°C/second max
$T_{S(max)}$ to T_L - Ramp-up Rate		3°C/second max
Reflow	- Temperature (T_L) (Liquidus)	217°C
	- Temperature (t_L)	60 – 150 seconds
Peak Temperature (T_p)		260 ^{+0/-5} °C
Time within 5°C of actual peak Temperature (t_p)		20 – 40 seconds
Ramp-down Rate		6°C/second max
Time 25°C to peak Temperature (T_p)		8 minutes Max.
Do not exceed		260°C

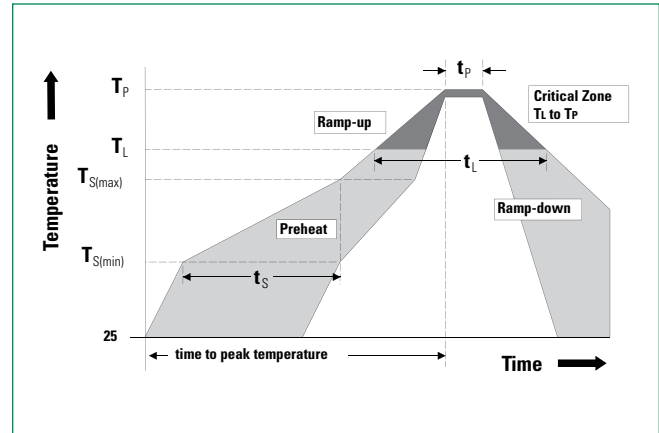

Product Characteristics

Lead Plating	Matte Tin, Pre-Plated Frame
Lead Material	Copper Alloy
Substitute Material	Silicon
Body Material	Molded Compound
Flammability	UL Recognized compound meeting flammability rating V-0

Ordering Information

Part Number	Package	Marking	Min. Order Qty.
SPHV12-01ETG-C	SOD882	B2	10000
SPHV15-01ETG-C		B5	
SPHV24-01ETG-C		B4	
SPHV36-01ETG-C		B6	
SPHV24-01KTG-C	SOD882 with side exposed leadframe	B4	10000

Part Marking System

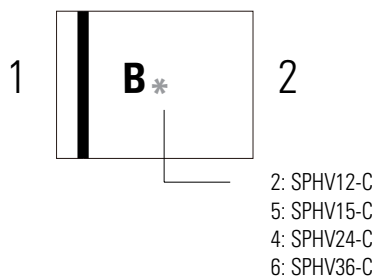

Part Numbering System

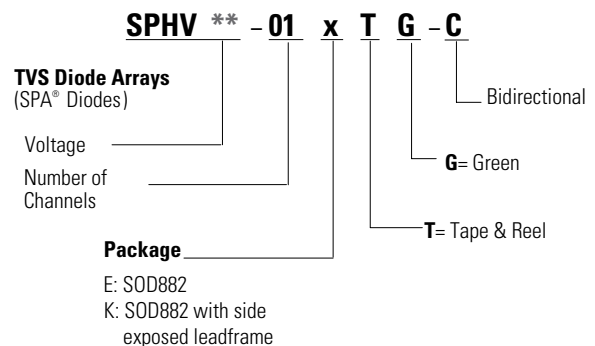

SPHV-C Series

200W Discrete Bidirectional TVS Diode

Package Dimensions — SOD882(SPHVxx-01ETG-C)

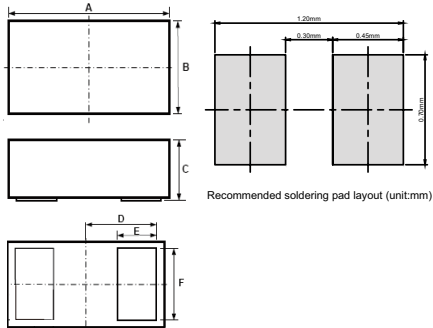

Symbol	Package	SOD882				
	JEDEC	MO-236				
	Millimeters			Inches		
	Min	Typ	Max	Min	Typ	Max
A	0.90	1.00	1.10	0.037	0.039	0.041
B	0.50	0.60	0.70	0.022	0.024	0.026
C	0.40	0.50	0.60	0.016	0.020	0.024
D		0.45			0.018	
E	0.20	0.25	0.35	0.008	0.010	0.012
F	0.45	0.50	0.55	0.018	0.020	0.022

Package Dimensions — SOD882 with side exposed leadframe(SPHV24-01KTG-C)

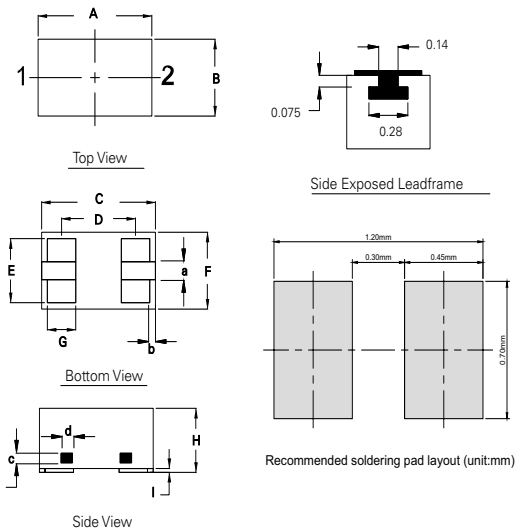

Symbol	Package	SOD882 with side exposed leadframe				
	JEDEC	MO-236				
	Millimeters			Inches		
	Min	Typ	Max	Min	Typ	Max
A	0.90	1.00	1.10	0.037	0.039	0.043
B	0.50	0.60	0.70	0.020	0.024	0.028
C	0.90	1.00	1.10	0.037	0.039	0.043
D	0.55	0.65	0.75	0.022	0.026	0.030
E	0.40	0.50	0.60	0.016	0.020	0.024
F	0.50	0.60	0.70	0.020	0.024	0.028
G	0.20	0.25	0.30	0.008	0.010	0.012
H	0.40	0.50	0.60	0.016	0.020	0.024
I		0.05 max		0.002 max		
a	-	0.14	-	-	0.006	-
b	-	0.05	-	-	0.002	-
c	-	0.075	-	-	0.003	-
d	-	0.10	-	-	0.004	-

Embossed Carrier Tape & Reel Specification

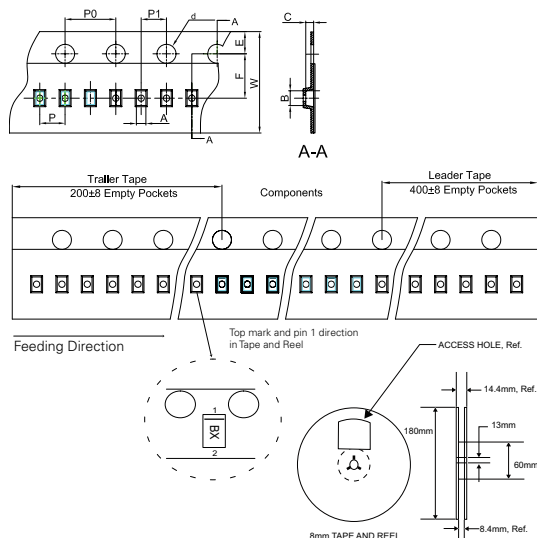

Symbol	Millimeters
A	0.70+/-0.045
B	1.10+/-0.045
C	0.65+/-0.045
d	1.55+/-0.10
E	1.75+/-0.05
F	3.50+/-0.05
P	2.00+/-0.10
P0	4.00+/-0.10
P1	2.00+/-0.10
W	8.00 + 0.30 -0.10

Disclaimer Notice - Information furnished is believed to be accurate and reliable. However, users should independently evaluate the suitability of and test each product selected for their own applications. Littelfuse products are not designed for, and may not be used in, all applications. Read complete Disclaimer Notice at <http://www.littelfuse.com/disclaimer-electronics>.