

AQ2555NUTG Series

Lightning Surge Protection

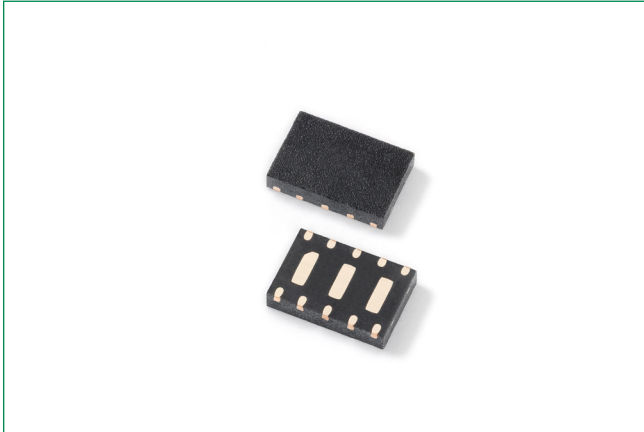

Description

The AQ2555NUTG is a low-capacitance, TVS Diode Array designed to provide protection against ESD (electrostatic discharge), CDE (cable discharge events), EFT (electrical fast transients), and lightning induced surges for high-speed, differential data lines. It's packaged in a μ DFN package (3.0 x 2.0mm) and each component can protect up to 4 channels or 2 differential pairs, up to 45A (IEC 61000-4- 5 2nd edition,) and up to 30kV ESD (IEC 61000-4-2). The "flow-through" design minimizes signal distortion, reduces voltage overshoot, and provides a simplified PCB design.

The AQ2555NUTG with its low capacitance and low clamping voltage makes it ideal for high-speed data interfaces such as 1GbE applications found in notebooks, switches, etc.

Features

- ESD, IEC 61000-4-2, ± 30 kV contact, ± 30 kV air
- •EFT, IEC 61000-4-4, 50A (5/50ns)
- Lightning, IEC 61000-4-5 2nd edition, 45A (tP=8/20 μ s)
- Low capacitance of 2.5pF@0V (TYP) per I/O
- Low leakage current of 0.1 μ A (TYP) at 2.5V
- PPAP capable
- μ DFN-10 package is optimized for high-speed data line routing
- Provides protection for two differential data pairs (4 channels) up to 45A
- Low operating and clamping voltage
- AEC-Q101 qualified
- Halogen free, Lead free and RoHS compliant
- Moisture Sensitivity Level(MSL -1)

Pinout

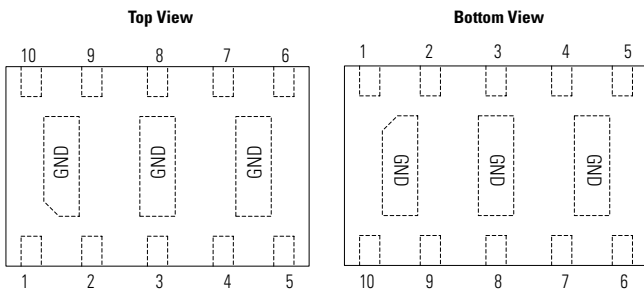

Note: PIN3, PIN8 are same potential with GND

Functional Block Diagram

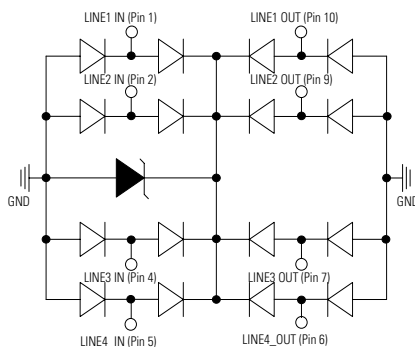

Life Support Note:

Not Intended for Use in Life Support or Life Saving Applications

The products shown herein are not designed for use in life sustaining or life saving applications unless otherwise expressly indicated.

Applications

- 10/100/1000 Ethernet
- WAN/LAN Equipment
- Desktops, Servers and Notebooks
- LVDS Interfaces
- Integrated Magnetics
- Automotive Application Notebooks

Application Example

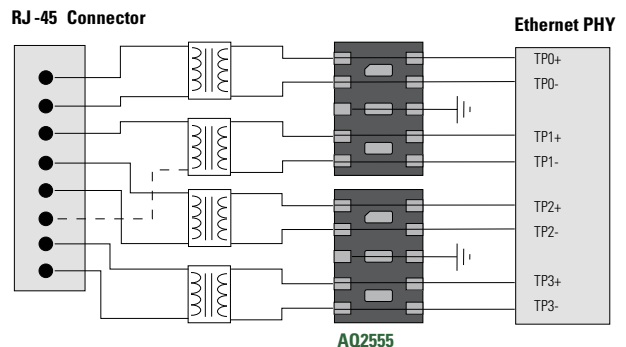

AQ2555NUTG Series

Lightning Surge Protection

Absolute Maximum Ratings

Symbol	Parameter	Value	Units
I_{PP}	Peak Current ($t_p=8/20\mu s$)	45	A
P_{Pk}	Peak Pulse Power ($t_p=8/20\mu s$)	1000	W
T_{OP}	Operating Temperature	-40 to 150	°C
T_{STOR}	Storage Temperature	-55 to 150	°C

Caution: Stresses above those listed in "Absolute Maximum Ratings" may cause permanent damage to the component. This is a stress only rating and operation of the component at these or any other conditions above those indicated in the operational sections of this specification is not implied.

Electrical Characteristics ($T_{OP}=25^\circ C$)

Parameter	Symbol	Test Conditions	Min	Typ	Max	Units
Reverse Standoff Voltage	V_{RWM}	$I_R \leq 1\mu A$			2.5	V
Reverse Leakage Current	I_R	$V_{RWM} = 2.5V, T = 25^\circ C$		0.1	0.5	μA
Snap Back Voltage	V_{SB}	$I_{SB} = 50mA$	2.0			V
Clamp Voltage	V_C	$I_{PP} = 1A, t_p = 8/20\mu s$, Any I/O to Ground		4.5		V
		$I_{PP} = 10A, t_p = 8/20\mu s$, Any I/O to Ground		7.5		
		$I_{PP} = 25A, t_p = 8/20\mu s$, Any I/O to Ground		12		
		$I_{PP} = 45A, t_p = 8/20\mu s$, Line-to-Line ¹ , two I/O Pins connected together on each line		19		
Dynamic Resistance ²	R_{DYN}	TLP, $t_p=100ns$, Any I/O to Ground		0.1		Ω
ESD Withstand Voltage	V_{ESD}	IEC 61000-4-2 (Contact)	± 30			kV
		IEC 61000-4-2 (Air)	± 30			kV
Diode Capacitance	$C_{I/O \text{ to GND}}$	Between I/O Pins and Ground $V_R = 0V, f = 1MHz$		2.5		pF
	$C_{I/O \text{ to I/O}}$	Between I/O Pins $V_R = 0V, f = 1MHz$		1.2		pF

Notes:

- Rating with 2 pins connected together per suggested diagram (For example, pin1 is connected to pin 10, pin 2 is connected to Pin 9, Pin 4 is connected to pin 7 and pin 5 is connected to pin 6)
- Transmission Line Pulse (TLP) with 100ns width, 2ns rise time, and average window $t1=70ns$ to $t2=90ns$

AQ2555NUTG Series

Lightning Surge Protection

Capacitance vs. Reverse Bias

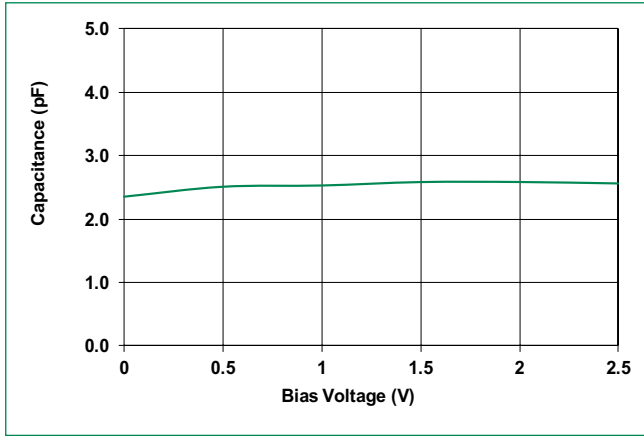

Clamping Voltage vs. IPP (I/O to GND)

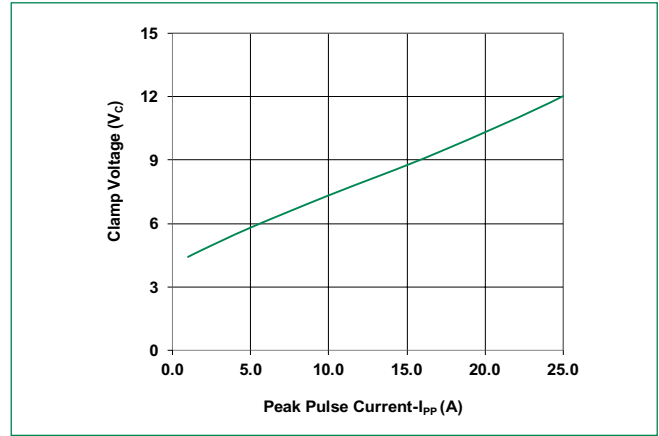

Clamping Voltage vs. IPP (Line-to-Line)

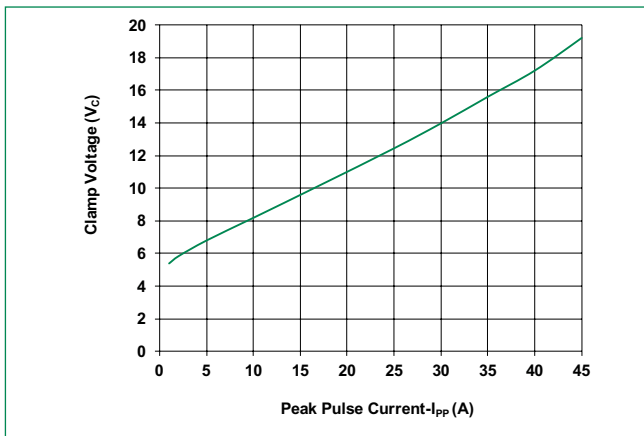

8/20µs Pulse Waveform

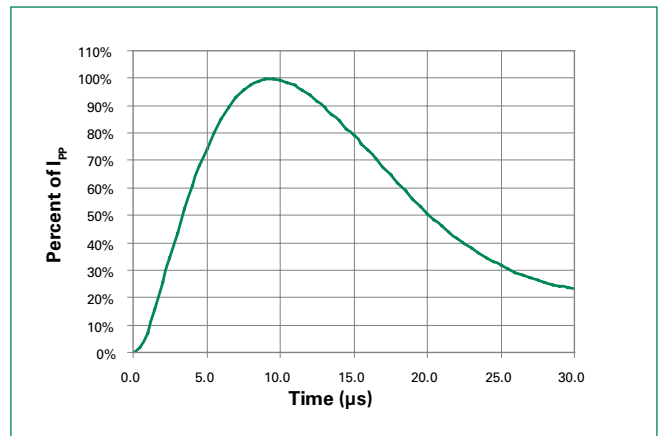

Transmission Line Pulsing(TLP) Plot

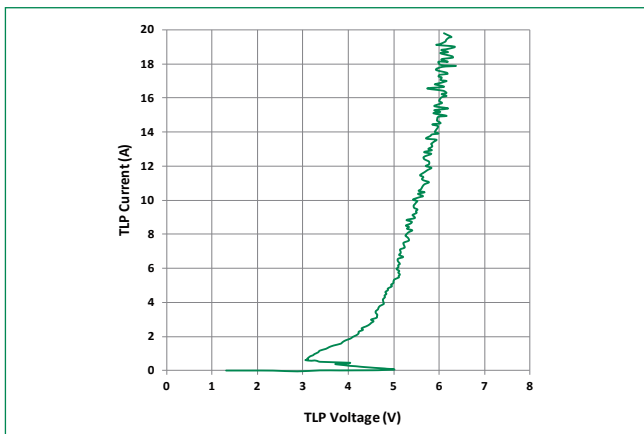

Power Derating Curve

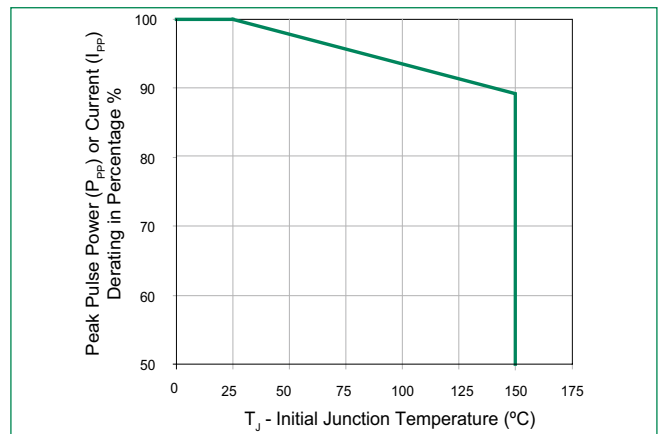

AQ2555NUTG Series

Lightning Surge Protection

Soldering Parameters

Reflow Condition		Pb – Free assembly
Pre Heat	- Temperature Min ($T_{s(min)}$)	150°C
	- Temperature Max ($T_{s(max)}$)	200°C
	- Time (min to max) (t_s)	60 – 120 secs
Average ramp up rate (Liquidus) Temp (T_L) to peak		3°C/second max
$T_{s(max)}$ to T_L - Ramp-up Rate		3°C/second max
Reflow	- Temperature (T_L) (Liquidus)	217°C
	- Temperature (t_L)	60 – 150 seconds
Peak Temperature (T_p)		260 ^{+0/-5} °C
Time within 5°C of actual peak Temperature (t_p)		30 seconds
Ramp-down Rate		6°C/second max
Time 25°C to peak Temperature (T_p)		8 minutes Max.
Do not exceed		260°C

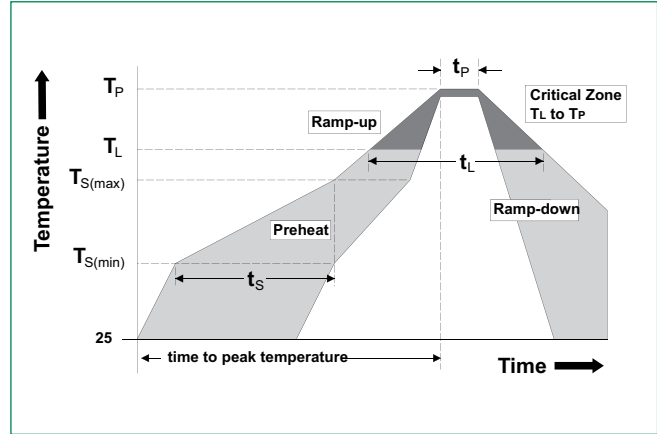

Ordering Information

Part Number	Package	Min. Order Qty.
AQ2555NUTG	μDFN-10 (3.0x2.0mm)	3000

Product Characteristics

Lead Plating	Pre-Plated Frame
Lead Material	Copper Alloy
Substrate material	Silicon
Body Material	Molded Compound
Flammability	UL Recognized compound meeting flammability rating V-0

Notes:

- All dimensions are in millimeters
- Dimensions include solder plating.
- Dimensions are exclusive of mold flash & metal burr.

Part Numbering System

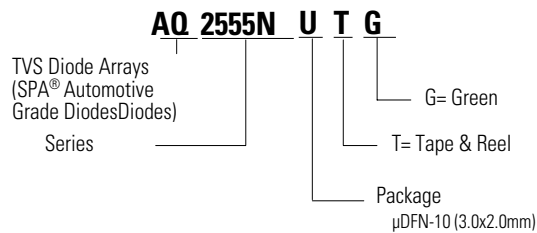

Part Marking System

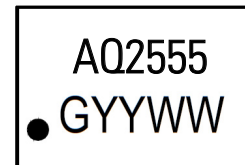

First row= Part Name= AQ2555
 Second row= Assembly Code+ Date Code

AQ2555NUTG Series

Lightning Surge Protection

Package Dimensions — μ DFN-10 (3.0x2.0mm)

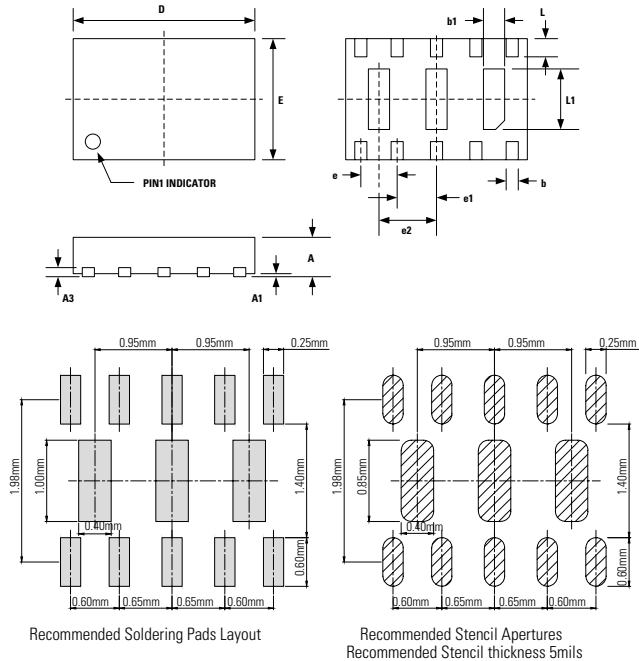

Package	μ DFN-10 (3.0x2.0mm)					
	JEDEC MO-229					
	Millimeters			Inches		
Symbol	Min	Nom	Max	Min	Nom	Max
A	0.50	0.60	0.65	0.020	0.024	0.026
A1	0.00	0.03	0.05	0.000	0.001	0.002
A3	0.15 Ref			0.006 Ref		
b	0.15	0.20	0.25	0.006	0.008	0.010
b1	0.25	0.35	0.45	0.010	0.014	0.018
D	2.90	3.00	3.10	0.114	0.118	0.122
E	1.90	2.00	2.10	0.075	0.079	0.083
e	0.60 BSC			0.024 BSC		
e1	0.65 BSC			0.026 BSC		
e2	0.95 BSC			0.037		
L	0.25	0.30	0.35	0.010	0.012	0.014
L1	0.95	1.00	1.05	0.037	0.039	0.041

Notes :

1. All dimensions are in millimeters
2. Dimensions include solder plating.
3. Dimensions are exclusive of mold flash & metal burr.

Tape & Reel Specification — μ DFN-10 (3.0x2.0mm)

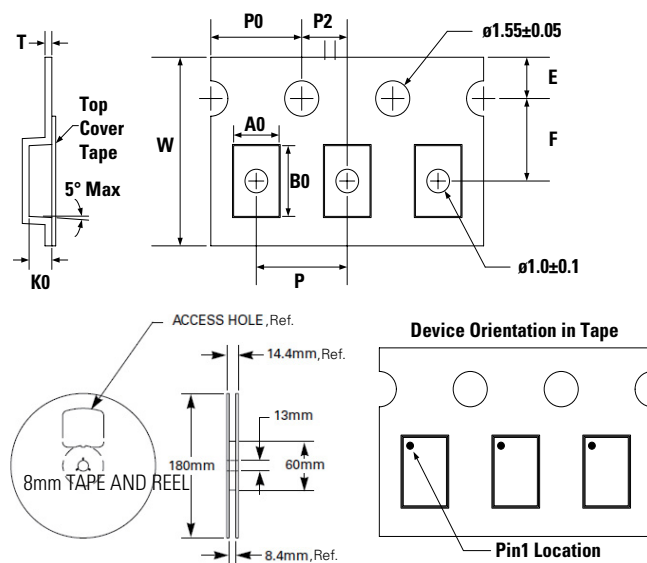

Package	μ DFN-10 (3.0x2.0mm)
Symbol	Millimeters
A0	2.30 +/- 0.10
B0	3.20 +/- 0.10
E	1.75 +/- 0.10
F	3.50 +/- 0.05
K0	1.0 +/- 0.10
P	4.00 +/- 0.10
P0	4.00 +/- 0.10
P2	2.00 +/- 0.10
T	0.3 +/- 0.05
W	8.00 +0.30/- 0.10

Disclaimer Notice - Information furnished is believed to be accurate and reliable. However, users should independently evaluate the suitability of and test each product selected for their own applications. Littelfuse products are not designed for, and may not be used in, all applications. Read complete Disclaimer Notice at <http://www.littelfuse.com/disclaimer-electronics>.